

# Data Sheet



Article number: 021500700043

Description: Sealing Clamp S 43 W5

## Measures

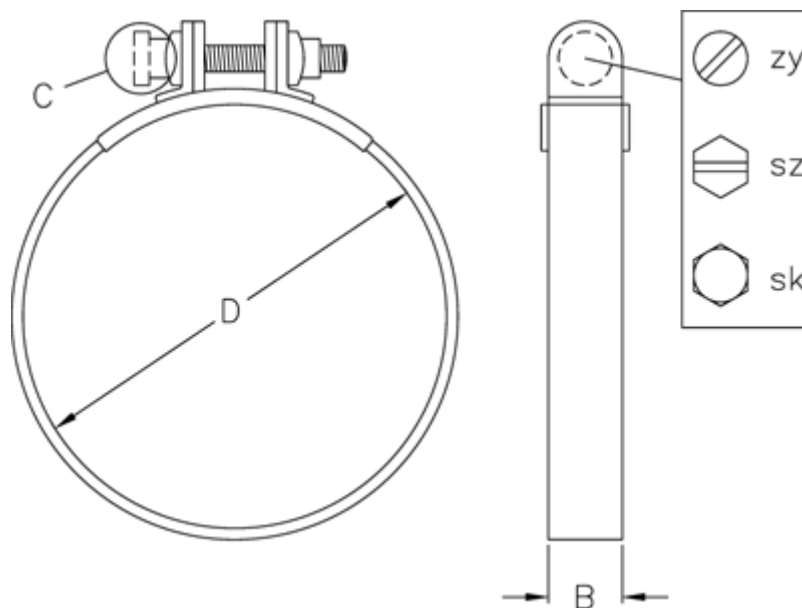

C (screw type) = SZ

Diameter D = 43

Width B = 20